

SPIDER (page1)

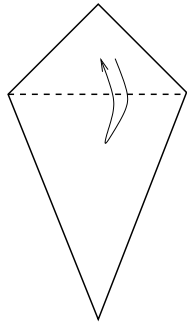

1. Start with a bird base.
Precrease.

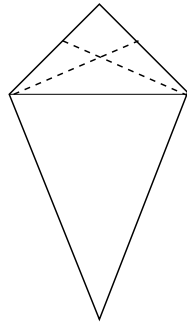

2. Precrease at angle
bisector.

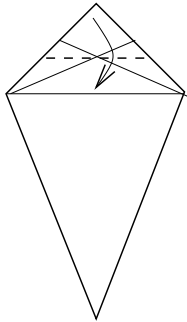

3. Valley fold at intersection
of creases.

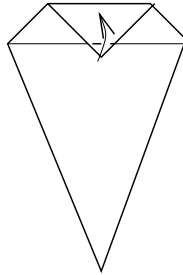

4. Valley fold up
as indicated.

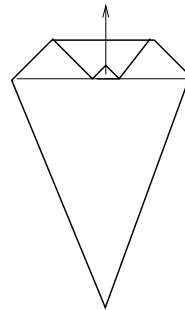

5. Open up.

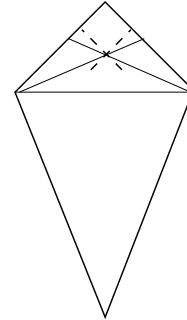

5. Precrease at right angle
through intersection of creases

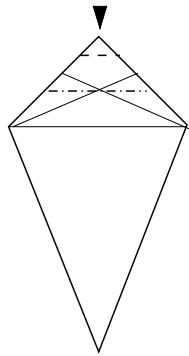

7. Double sink using
existing creases.

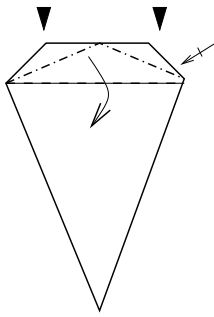

8. Spread squash using
existing creases.
repeat behind.

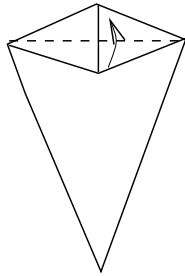

9. Close back up.
repeat behind.

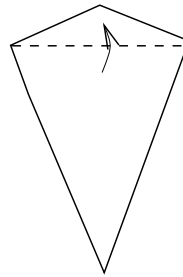

10. Valley fold one flap up.

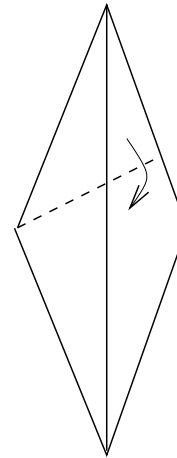

11. Valley fold at right angle.

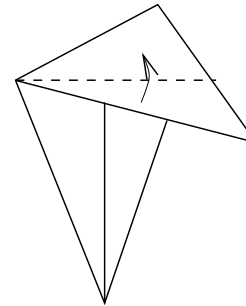

12. Valley fold up at angle
bisector.

SPIDER (page2)

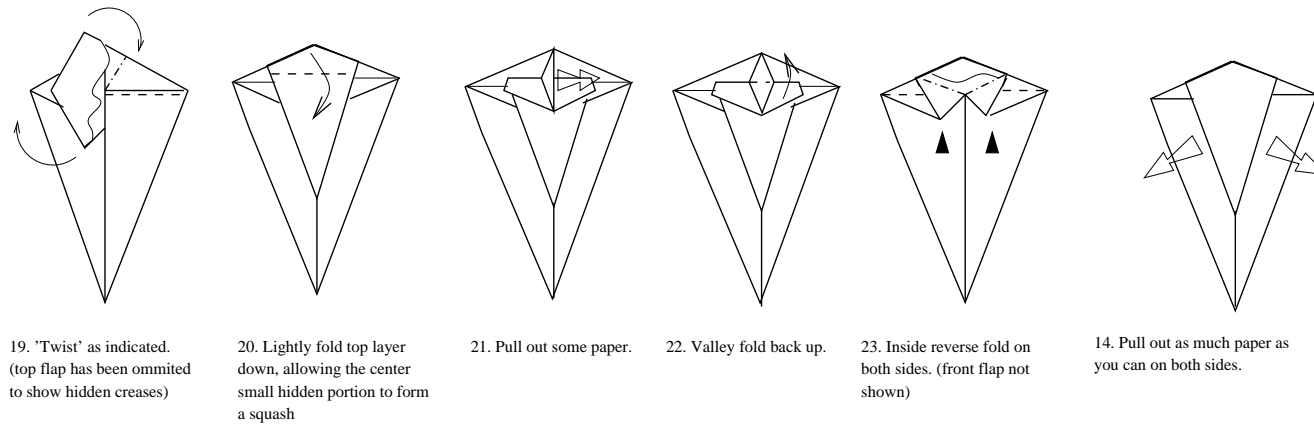
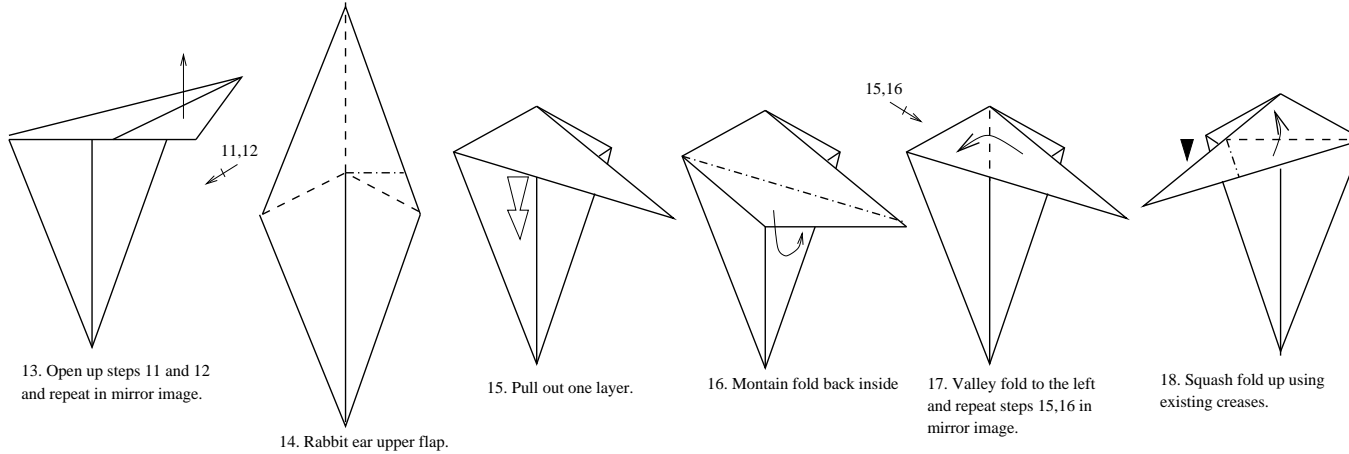

SPIDER (page3)

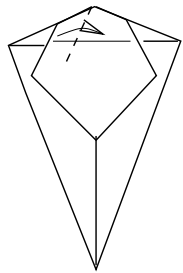

25. Slightly valley fold so that corner lies on horizontal crease, while allowing hidden flap to squash.

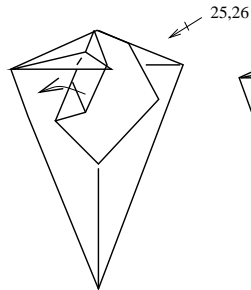

26. Valley fold back left and repeat step 25,26 in mirror image.

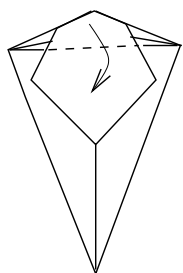

27. Slightly valley fold two flaps down.

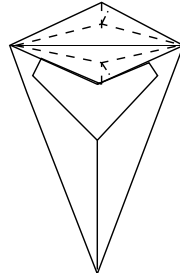

28. Rabbit ear upper and lower flap

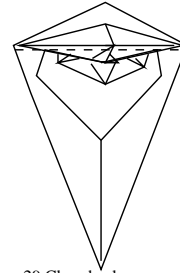

29 Close back up.

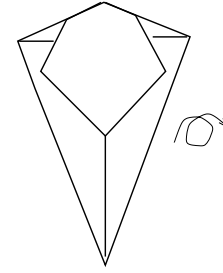

30. This will form the abdomen. Turn over.

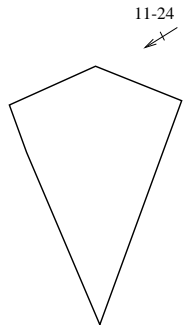

31. Repeat steps 10-23 on this side.

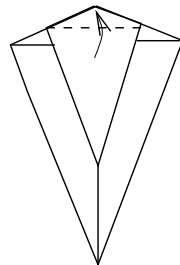

32. Valley fold front small flap up.

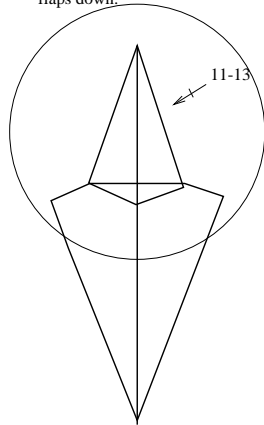

33. Repeat section 11-13 on the upper triangular section. Next drawings are a zoom of the upper section.

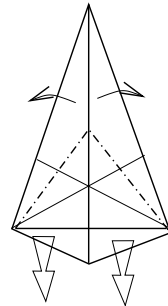

34 Pull out some paper while opening both front layers.

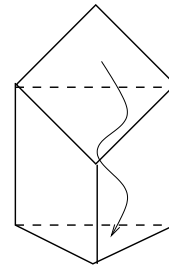

35. Valley down two times.

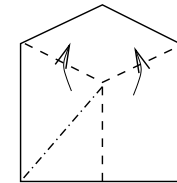

36. Rabbit ear using existing creases

SPIDER (page4)

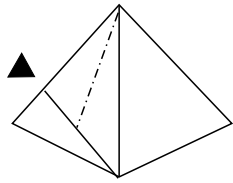

37. Inside reverse fold

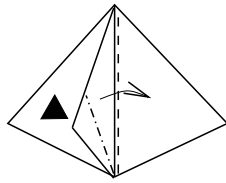

38. Squash fold.

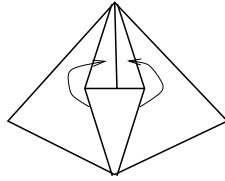

39. Bring one layer to front on both sides.

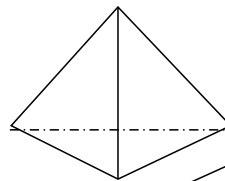

40. Close sink one flap.

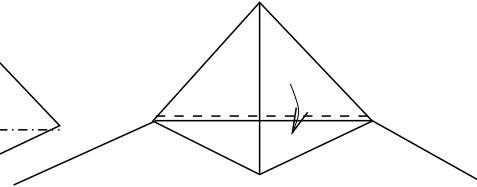

41. Valley fold down.

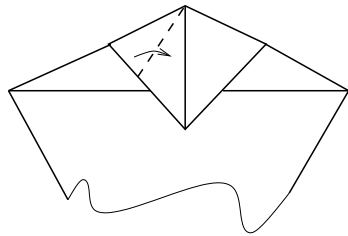

42. Valley fold so that corner lies on horizontal crease, allowing hidden flap to squash.

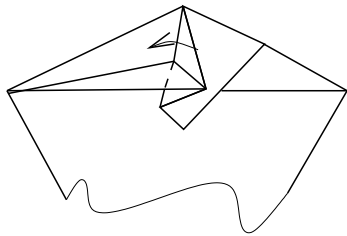

43. Valley fold to the left and repeat in mirror image.

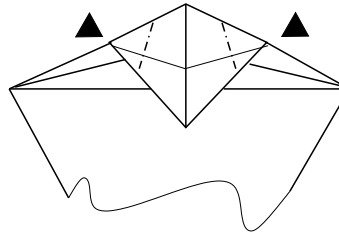

44. Inside reverse fold so that corner meets intersection of previous creases.

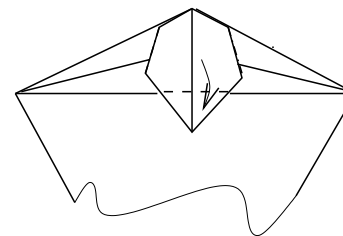

45. slightly valley fold two flaps down.

SPIDER (page5)

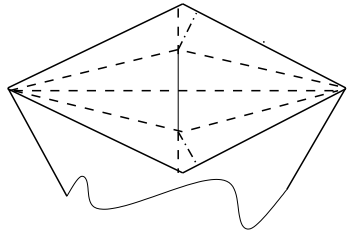

46. Rabbit ear upper and lower flap then close back to step 45. Next drawings are full view again.

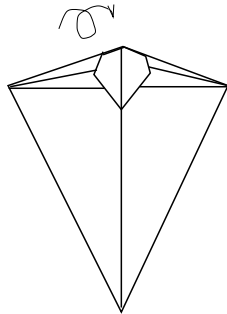

47. This will form the head.
Turn over

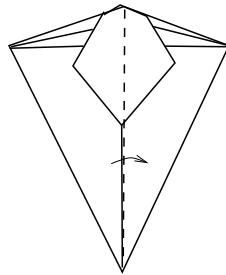

48. Fold two flaps to the right.

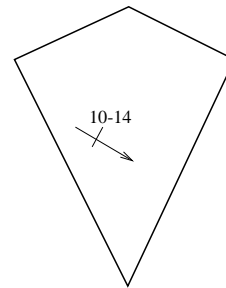

49. Repeat steps 10-14 on lower flap.

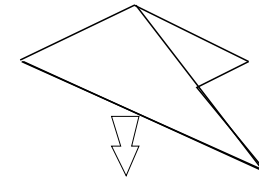

50. Only front flap is drawn
Pull out some paper.

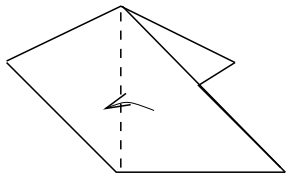

51. Valley fold to the left.

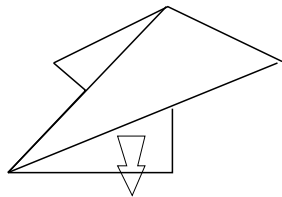

52. Pull out some paper.

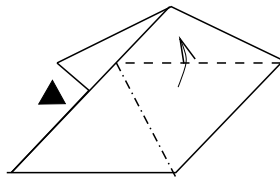

53. Squash fold up.

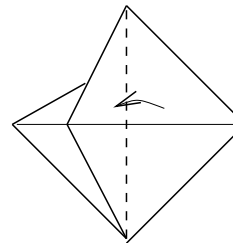

54. Valley fold left.

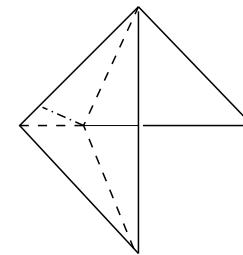

55. Rabbit ear.

SPIDER (page6)

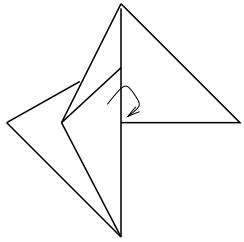

56. Reverse fold to put front flap inside the socket hidden beneath.

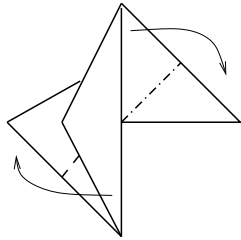

57. Twist as indicated.

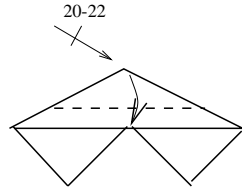

58. Repeat steps 20-22 on the upper front flap.

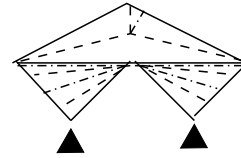

59. Inside reverse fold four times on both sides. Rabbit ear top flap.

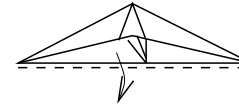

60. Valley fold two flaps down.

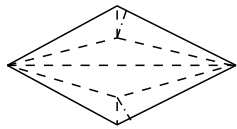

61. Rabbit ear both flaps and close back up.

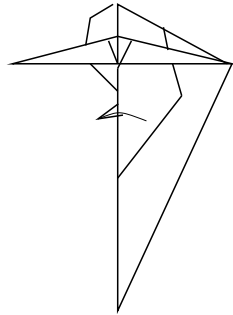

62. Full view. Valley fold left to restore the abdomen at front.

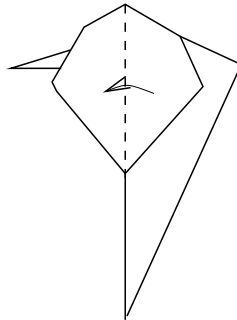

63. Valley fold two flaps to the left.

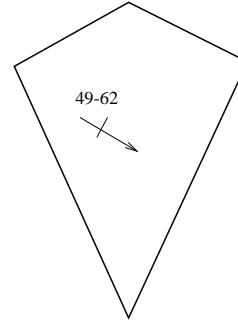

64. Repeat steps 49-62 on this side to form the four remaining legs.

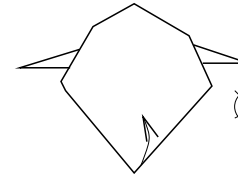

65. Raise the abdomen bottom corner at 90° . Previous creases will move and model will not lie flat any more.

SPIDER (page7)

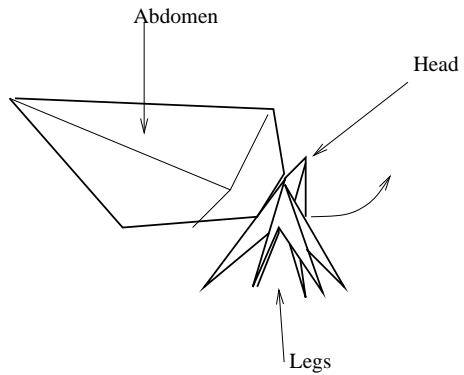

66. Schematic side view.
Raise the head at 90° without adding any creases. Old creases will move to make it possible.

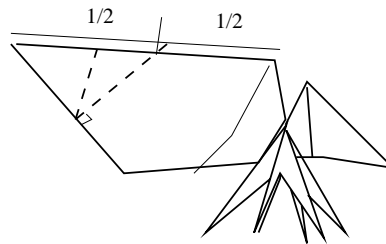

67. Precrease.

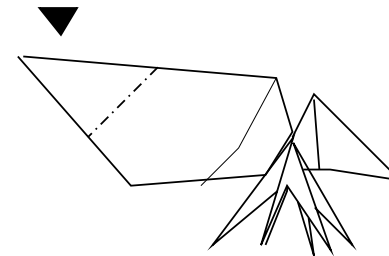

68. Inside reverse fold using precrease.

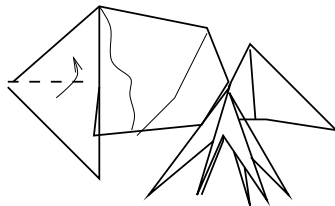

69. Valley fold up the flap hidden inside the abdomen, to lock it 3D.

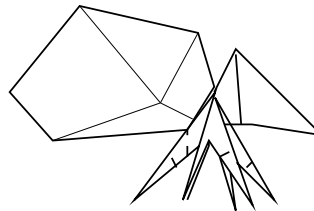

70 Shape the legs at your convenience.

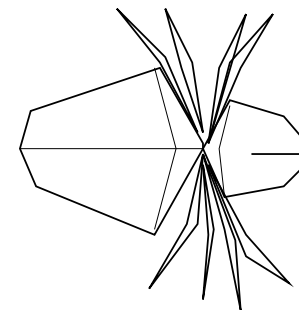

71. Schematic view of the finished spider.